

Airthings Wave

Smart Radon Detector

Operating Manual





Version 2, May 2, 2018

Set up your Airthings device in 3 simple steps:

1. Download the Airthings Wave App, available on iOS and Android
2. Create an account and insert Name, Email and Location*
3. Follow the simple instructions in the app to connect your device

*We encrypt and securely store your information in the Airthings Cloud. Providing your location is optional, however, sharing your radon information helps us understand how regional radon works and can ultimately save lives.

Many easy ways to contact Airthings

			
Online	By email	By phone	Social media
Look at our frequently asked questions, or contact us directly through our support form. support.airthings.com	Send an email directly to support at support@airthings.com	Customer service in English: US +1 (866) 254-2221 CA +1 (866) 222-2117 Norway +47 21 40 37 62 Global +44 808 169 5752 Open Mon-Fri 7:00-1:00am Central European Time	Message us on facebook, Twitter, LinkedIn or Instagram! 👤 Airthings 🌐 Airthingsglobal 📷 Airthings 🌐 Airthings

Have any questions or comments that we didn't get to here? Please let us know! support.airthings.com

Congratulations on taking this important step toward living a healthier life.

By keeping track of your radon levels, you can make healthier decisions in the spaces where you spend most of your time. Lessening your exposure to radon will reduce your risk of lung cancer.

The Airthings Wave provides you with detailed information about Radon, Temperature, and Humidity levels on your phone, Airthings Dashboard or simply wave in front of the device for a visual indication of your radon levels.

Breathe better, live better,

The Airthings team

Features and conten

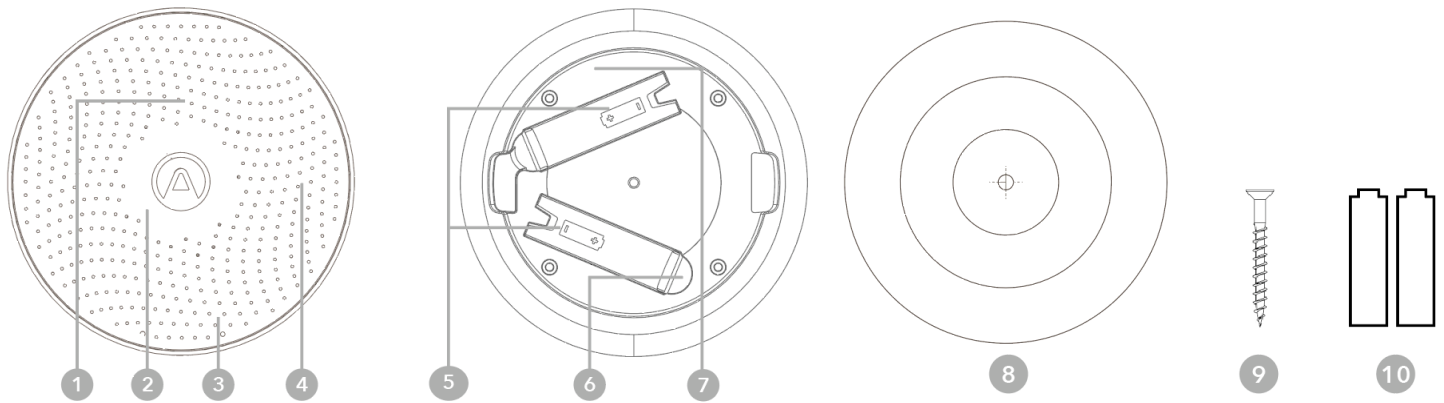

1. Power indicator
2. Light ring
3. Motion sensor
4. Air inlets
5. Battery compartments (observe polarity symbols)
6. One-time battery tab
7. Individual serial number
8. Mounting bracket
9. Screw
10. 2 AA batteries, inserted

Power indicator

Flashing dot every 20 seconds

Green: battery level okay

Blue: Bluetooth connectivity active

Red: Replace batteries

Light ring

Visual indication of your air quality levels.



Green: Good

Yellow: Warning

Red: Danger

(Go to airthings.com/mylevels for more information on air quality action levels)

Air inlets

This is where air comes into your detector.

Audio alarm

The device can give you audio alerts if your air quality levels are violating the recommended amount. In case of audio alerts, simply wave in front of the device to snooze alerts.

Wave sensor

Simply wave in front of your detector to activate the light ring.

Easy to mount

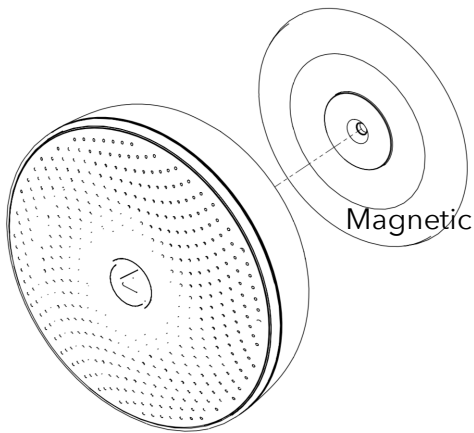

Fix the mounting bracket to the ceiling or wall. Make sure you use appropriate screws for your wall type. The screws included are intended for wood or drywall. Do not place it close to vents or windows. Minimum 1 meter / 3 feet distance.

Thanks to the built-in magnet, simply snap the unit onto the mounted bracket. Then rotate it to the desired position.

Daily use

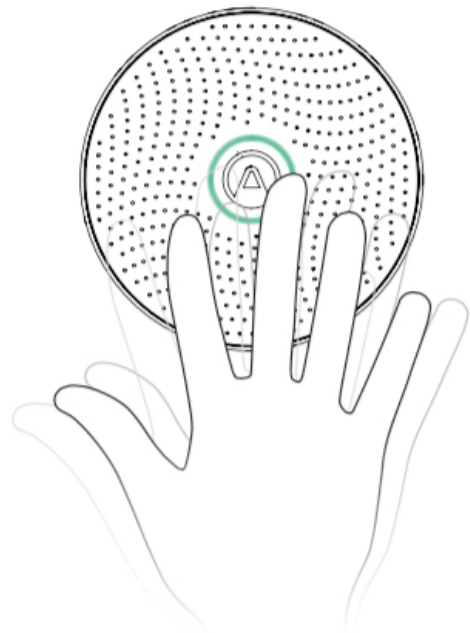

Wave in front of your device to see a visual indication of your daily radon levels. Leave your Wave uninterrupted for at least 1 week to get a quality average reading for radon.

Basics of the App

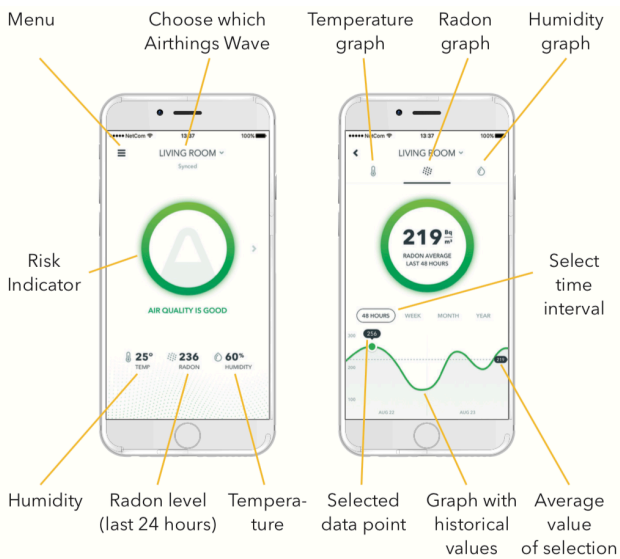

For the U.S.A. radon levels are shown in pCi/L

Make sure you always have Bluetooth enabled on your phone and the app running in the background. Every time you move within Bluetooth range of your device, the latest data will be downloaded automatically.

You will be notified if any actions are needed through the app.



Integrations



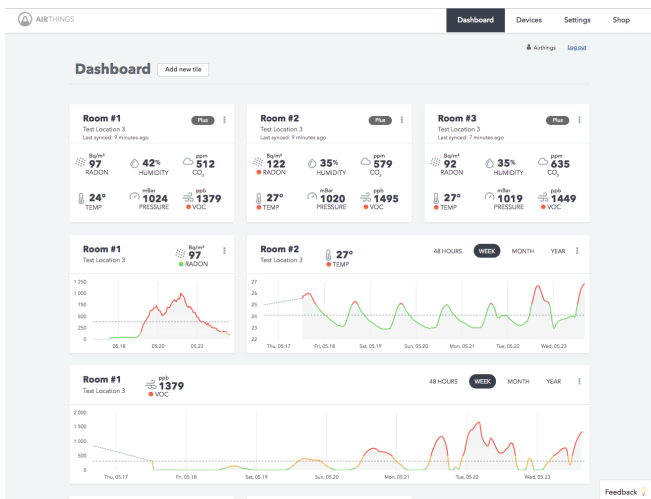

The Airthings Wave shares data to your mobile device as well as the Airthings Dashboard—a free online platform that provides quick access to view, customize and analyze sensor data from multiple Airthings devices.



The Airthings Wave is integrated with Amazon Alexa and IFTTT. With Amazon Alexa, use voice commands to control your device. IFTTT integration allows users to create or access useful recipes for their device to follow and integrate with third-party products. Sign up for our newsletter for the latest updates.



Glow ring

<p>Spinning: Ready to pair Flashing: Pairing</p>		<p>The blue light is used to display Bluetooth status. When it is spinning blue, the device is ready for pairing and it will stay in that mode for 1 minute. Knock gently on the detector to restart pairing process or check status. If your detector has already been paired, the blue light will flash twice.</p>
<p>Waiting for first result</p>		<p>After a successful setup, wait up to 1 hour to receive your first radon measurement.</p>
<p>Good Air quality is good Spinning: updating internal software</p>		<p>Your radon level is below the recommended level according to the EPA and WHO levels, which is 100 Bq/m³ or 2.7 pCi/L.</p>
<p>Warning Above recommended level, keep measuring</p>		<p>If your radon level is below 100-150 Bq/m³ or 2.7-4 pCi/L, a longer measurement is needed to get a qualified measurement.</p>
<p>Danger Above recommended level and action should be taken to lower your radon levels</p>		<p>Measurements are above the recommended level. Actions should be taken to lower radon levels.</p>

Sensor icons



Temperature – Indoor temperatures can affect performance, mood and comfort level. Individual sleep patterns are also affected by indoor air temperature.



Radon – Decrease exposure to this radioactive gas that accumulates in buildings and homes. It is the number one cause of lung cancer among non-smokers but can be managed with continuous monitoring.



Humidity – Too much or too little humidity can affect allergies and cold or flu symptoms. When humidity levels are too high, mold and rot will occur. Low humidity levels cause static electricity, dry skin and hair, and increased susceptibility to colds and respiratory illness.

Color coding and action levels

Sensor	Unit		Color
	US	ROW	
Radon* *If radon levels remain red for over 1 month, contact your local health authority	pCi/L	Bq/m3	Bq/m3: ● <100 ● ≥100 <150 ● ≥150 pCi/L: ● <2.7 pCi/L ● ≥2.7<4 ● ≥4
Temperature	°F	°C	Celsius: ● <18 ● ≥18 and ≤25 ● >25 Fahrenheit: ● <64 ● ≥64 and ≤77 ● >77
Humidity	%	%	● <25 ● ≥25<30 ● ≥30<60 ● ≥60<70 ● ≥70

Troubleshooting

First and foremost, always make sure that you have updated to the latest device software

- In the device settings menu, click update device.

Not able to connect to my device

- Make sure you have the detector within the range of 2-5 meters or 5-15 feet.
- Check if Bluetooth is turned on.
- Check if the power indicator is blinking.

Need to turn off the audio alert

- In the iOS app, go to device settings menu and update radon alarm settings.
- Wave in front of the detector to snooze for 1 month.

My app is not updated when running in background mode

- Open your phone settings and verify that the Airthings Wave app is running in the background. You can usually find this in the app manager section of your phone settings.
- Make sure you are in Bluetooth range periodically.

No response from light ring

- Check if the power indicator is blinking.
- If the power indicator is blinking red, or not blinking at all, the battery level is low. First, sync your data and then replace the batteries. We recommend AA alkaline (LR6).

If you need further assistance, read our [Frequently Asked Questions](#), or simply contact support at support.airthings.com.

Technical specifications

Power supply: 2 AA 1.5V alkaline (LR6)
3.0V nominal (2x1.5V)
3.8V maximum, 1.8V
minimum (depleted batteries)
500mA max current draw

Dimensions: Diameter: 120 mm (4.72in)
Height: 36 mm (1.42in)

Weight: 219g including 2 batteries (7.7 oz)

Operational and storage environment:
Temperature: 4 °C (39 °F) to +40 °C (104 °F)
Relative humidity: < 85%

Initial accuracy/precision at 100 Bq/m³ (2.7 pCi/L):
7 days < 10%
2 months < 5%

Measurement range: 0 Bq/m³ to 50,000 Bq/m³
(0 pCi/L to 1350 pCi/L)

Within the first week, the accuracy levels of the Airthings Wave are within 10% at one standard deviation, measured at 100 Bq/m³ (2.7 pCi/L). After a month, the accuracy

increases drastically to within 5% at one standard deviation, measured at 100 Bq/m³ (2.7 pCi/L). As the device gathers data, the accuracy of readings increases drastically.

All Airthings detectors have been tested directly against the AlphaGUARD reference device—the professional radon monitoring benchmark with which all radon detectors and tests are referenced.

Safety and maintenance

The Airthings Wave Plus is intended for indoor use only. Avoid direct exposure to sunlight for long periods. Avoid exposure to direct heat sources. For correct usage, make sure the detector is operating in the specified temperature range (see technical specifications).

Exposure to high humidity might permanently alter the detector sensitivity or damage it.

Do not disassemble. If the detector does not work as specified or you are in doubt, contact your local dealer or visit us at Airthings.com.

Use a dry cloth to clean the detector.

When replacing the batteries, pay attention to the polarity marks. Use AA alkaline (LR6) batteries.

Always snap the mounting bracket to the detector's rear side to protect the batteries, even when the detector is not permanently mounted.

Disposal: electronic equipment.

Limited liability

The instrument is tested and quality-assured by production. It meets the accuracy values set out in the specifications.

It is recommended to keep the instrument constantly activated and the batteries in place until drained.

Airthings AS shall not be liable for damages related to failure or loss of data arising from incorrect operations and handling of the instrument.

Terms & conditions

airthings.com/terms-use-privacy/

For other languages or additional questions go to support.airthings.com

The Bluetooth word mark and logos are registered trademarks owned by the Bluetooth SIG, Inc. and any use of such marks by Airthings is under license.

Copyright Airthings AS 2018